



 **Termoakim**<sup>®</sup>  
heating systems

**GALAXI PRO SLIM**

**ELECTRIC BOILER**



**MADE IN  
TÜRKİYE**









## HIGHLIGHTS FEATURES

- Offers an aesthetic appearance with its minimized dimensions and exterior design.
- 99% efficient operation.
- Safe operation with the digital display control panel where the fault information about the device is obtained.
- Rating modulation of DHW and radiator temperature separately, saving 12%.
- Specially designed chrome resistance.
- Boiler (external hot water tank) installation and control.
- Boiler temperature probe connection and three-way valve output.
- Underfloor heating compatible.
- Room thermostat output.
- Limit thermostat against overheating.
- Pump blockage protection.
- Frost protection.
- Circulation pump control output.
- Low pressure switch output.
- Electronic water temperature control with NTC system (sensitive heat sensor).

## CONTROL PANEL and KEY FUNCTIONS



	Up and Increased Button.
	Down and Decreased Button.
	Device Standby / Activation Button.
	Temperature Adjustment Button.
	Boiler Mode Button.
	Winter Mode Key.



## PARTS OF THE DEVICE

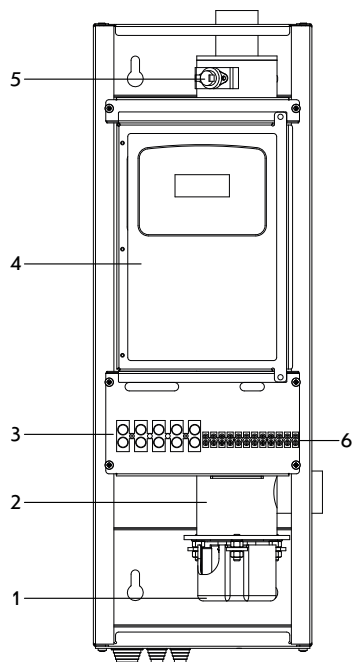

1. Heating Element
2. Boiler Body
3. Input Terminal
4. Control Panel
5. Safety Thermostat
6. Distribution Terminal

## DIMENSIONS and TECHNICAL SPECIFICATIONS

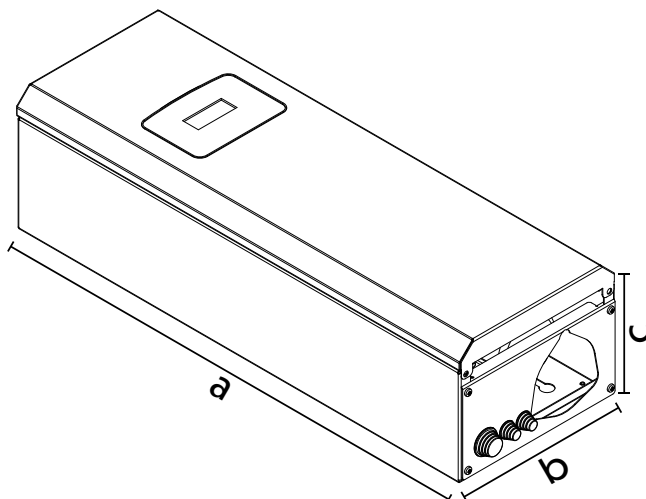

FEATURES	PROS-4.5		PROS-6		PROS-9		PROS-12		PROS-14	
Power (kW)	4.5		6		9		12		14	
Electric Type	<i>Monophase</i>	<i>3-phase</i>	<i>Monophase</i>	<i>3-phase</i>	<i>Monophase</i>	<i>3-phase</i>	<i>Monophase</i>	<i>3-phase</i>	<i>Monophase</i>	<i>3-phase</i>
Electrical Connection (V-50 Hz)	230	400	230	400	230	400	230	400	230	400
Capacity (kcal/h)	3.870		5.160		7.740		10.320		12.040	
Amper (A)	20	7	27	10	41	14	55	19	63	21
Recommended Fuse (A)	20	10	32	16	50	20	63	20	63	32
Recommended Leakage Relay (A)	25	16	40	25	63	25	63	25	63	40
Device Connection Cable (mm <sup>2</sup> )	3x4	5x2,5	3x4	5x2,5	3x6	5x2,5	3x10	5x4	3x10	5x4
Operating Pressure (bar)	2									
Boiler Temperature Range (°C)	40-75									
Radiator Flow Diameter (inch)	3/4									
Device Size a <b>x</b> b <b>x</b> c (mm)	590x205x158									
Packaged Device Size a <b>x</b> b <b>x</b> c (mm)	640x260x225									
Weight (kg)	9									
Packaged Weight (kg)	10									

# INSTALLATION DIAGRAMS

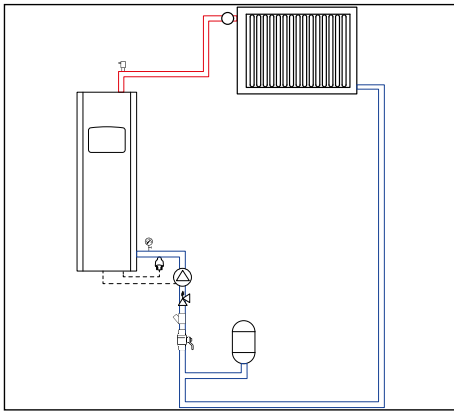

Electric boiler, radiator wiring diagram.

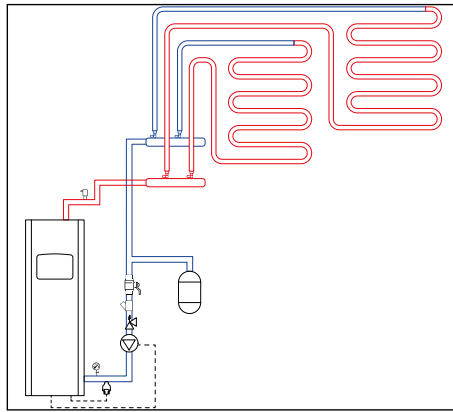

Electric combi underfloor heating wiring diagram.

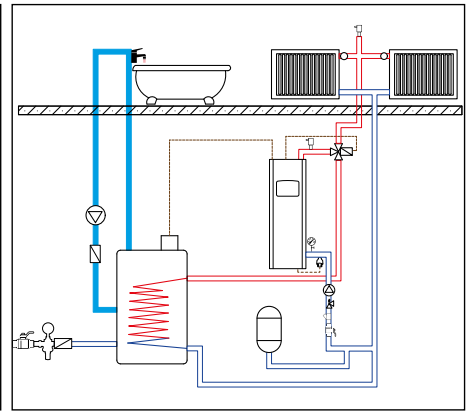

Electric boiler, boiler and radiator connection diagram.

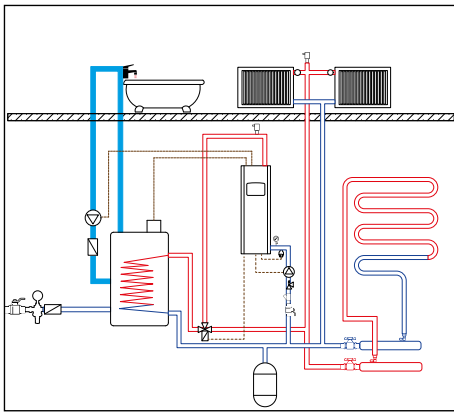

Electric boiler, boiler, radiator, floor heating wiring diagram.

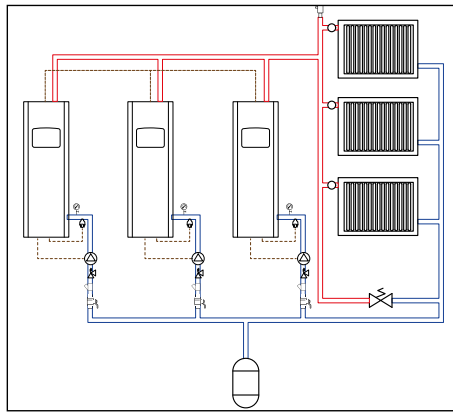

Electric boiler cascade wiring diagram.

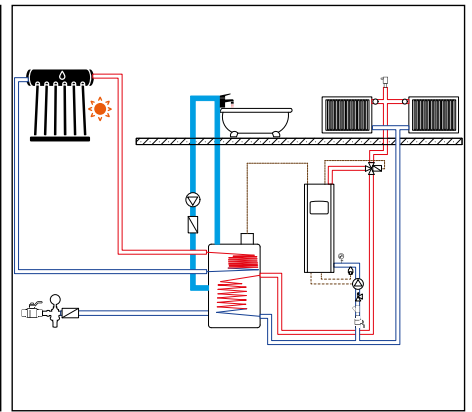

Electric boiler, solar powered boiler and radiator wiring diagram.

# PARALLEL CONNECTION WITH OTHER DEVICES

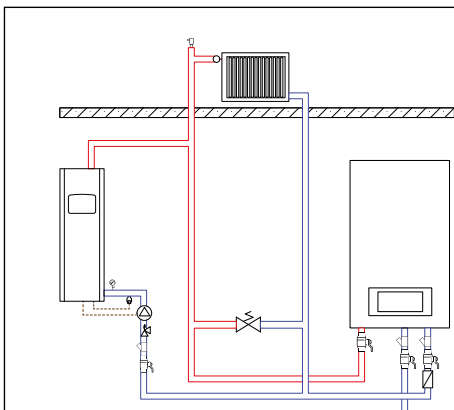

Electric combi boiler and gas combi boiler parallel connection diagram.

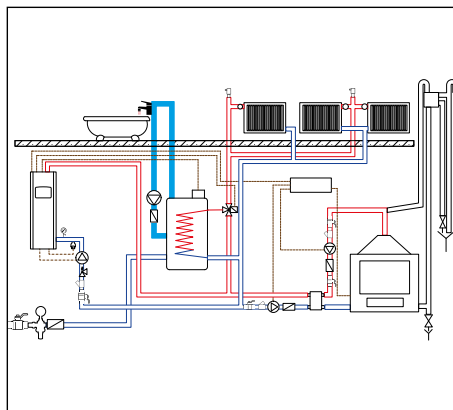

Connection diagram to electric boiler, boiler, radiator, water fireplace and similar devices.

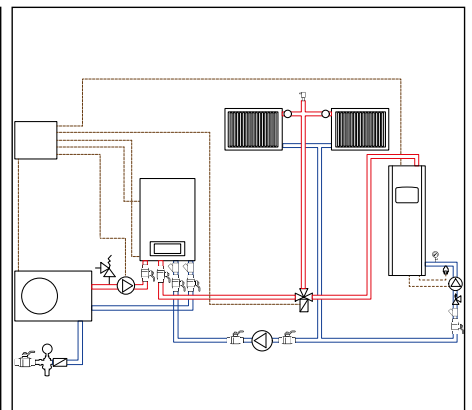

Electric boiler and heat pump parallel connection diagram.